

# Future Knee Modular System

## Surgical Technique



BIOTECH GmbH  
Hagenauer Str. 17-19,  
65203 Wiesbaden,  
GERMANY  
Telephone: +49 611 89063143  
Fax: +49 611 89063145  
Email: office-de@biotech-medical.com

[www.biotech-medical.com](http://www.biotech-medical.com)



# BIOTECH

REF:  
VB-004-PROSP-ST-01\_04\_05\_08-EN-00

Revision  
2

Publication date :  
01.04.2022.

CE 1011

# "Movement is Life"

**BIOTECH FUTURE KNEE**  
**Minimal Invasive (and classic)**  
**Surgical Technique**

	<b>Page No.</b>
Product description	2.
Pre-operational planning	3.
<b>1st step</b>	
Femoral resection	4.
P/S Femoral component	7.
<b>2nd step</b>	
Proximal tibial resection – The extramedullary technique	8.
Proximal tibial resection – The intramedullary technique	9.
<b>3rd step</b>	
Fixing up the trial femoral component	14.
<b>4th step</b>	
Trial replacement	
Checking of the flexion and extension joint gap	16.
FUTURE Knee rotating tibia implantation	
<b>5th step</b>	
Final preparation of the tibia plateau	17.
<b>6th step</b>	
Preparation of the patella	20.
<b>7th step</b>	
Mounting of the original implants	22.

## Product Description:

### FUTURE KNEE 1 –Total Knee System



### FUTURE KNEE MODULAR –Total Knee System

**Cruciate retaining femoral components** exist in both left and right anatomical designs made of Cobalt Chrome raw material. The condylar gilding surfaces are centralized in 5 degree angle over opposite paths. **Posterior stabilized femoral components** are made of Cobalt Chrome raw material and anatomically shaped. The special geometrical features of the condyles along with the central directional box, guarantee the high joint stability of the special P/S tibial inlay.

The prostheses are available in 7 different sizes (XXS, XS, S, M, L, XL, XXL), to comply with the different physiologically determined properties.

By variation of the tibial and the femoral components, the inlay that is most suitable for the given anatomical characteristics can be chosen.

#### **Compatibility of sizes**

Each femoral component is compatible also with the next size of tibial component (one size lower or upper).

#### **Tibial base components and inserts**

Cemented and uncemented tibia plate versions made of Cobalt Chrome are available with primary or posterior stabilized UHMWPE inserts, in different sizes. The wing -designed tibial platform ensures a stable and long-lasting fixation.

#### **Patella component**

The 1 pegged, dome-shaped patellar component is available in cemented UHMWPE version. The correct placement and long-lasting fixation are ensured by the introduction of the peg.

## **Pre-operational planning**

When performing a complete joint replacement, two aims are to be considered primarily: The full shaft adjustment, and the restoration of function.

The correct adjustment of the limb is ensured by using the appropriate instrumentation sets. For the sake of restoring full functionality to the joint the surgeon has to properly adjust the arches of the loins.

For the right determination of the tibial and femoral mechanical and anatomical axis adjustments, it is recommended to prepare an X-ray of the long leg axis.

The mechanical axis extends medially from the femoral head along the centre of the knee, and up to the middle of the ankle.

On the basis of the X-ray made, it can be assured that the use of intramedullary devices will not be obstructed by the presence of a bone anomaly or the implanted prosthesis.

The tibiofemoral valgus angle can be measured with the help of a goniometer, or with an angle gauge. The angle is usually 5 to 10 degrees.

The femoral outer reaction line is at right angles to the mechanical line, and can be found parallel to the joint line.

The maximum tolerated angle deviation from the appropriate axis placement should not exceed 3°, any higher value could lead to the damage of the prosthesis.

For the determination of the approximate size of prosthesis, it is advisable to use an x-ray template. Moreover, the likely use of bone material or bone lining blocks for the reconstruction should be determined pre-operatively.



The **BIOTECH FUTURE KNEE - Total Knee System** instruments set, is suitable for implanting the femoral and tibial components (and the patellar component if needed) by classic and minimal invasive technique.

After opening the area by the usual technique, the front surface of the femur is freed up by performing a partial Synovectomy, thereby making it possible to take the correct measurements. Position the retractors in place, and then cut off the meniscuses and the front part of the cruciate ligaments. Remove any osteophytes that may act as obstacles in the way of the aiming device.

## **1st step** **Femoral resection**

With the help of a drill (Picture 1.) or an awl open up the intramedullary canal. Stay along the axis area of the marrow.



Then assemble together the slotted rod (735-0019-0001) with the T-handle (Picture 2.), and insert the rod carefully into the intramedullary canal (Picture 3.) with rotating movements, until the coned end reaches the isthmus.



Now remove the T-handle, and fit the distal femoral cutting guide (735-1018-0002) on to the rod. (Picture 4.)



With this, set the desired degree of “valgus” axis position, and then using an oscillating saw perform the distal resection of the femur (Picture 5.)

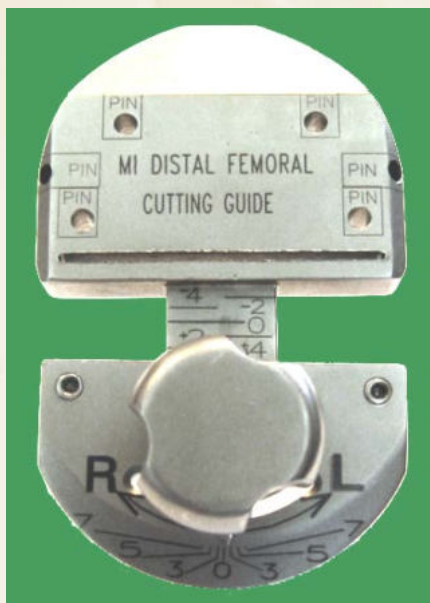

Next, depending on the given intra-operative circumstances, the proximal tibial end resection may be performed, prior to the continuation of the femoral resection. After that, carry on with the measurements, and the final shaping of the femoral component's place.

#### **Continuation of the femoral resection:**

If tissues condition permits, then the next step will be the positioning of the femoral sizer and drill guide. (735-1008-0002), (Picture 6.).

This will help in determining the right size of the femoral component to be used, adjusting its outer rotation (with fixation pins), and preparing the suitable holes for the prosthesis base.

Make sure that the edges of the block fall at equal distances from the medial and lateral sides of the epicondyles. By turning the screws at the top of the femoral sizer, the indicators in the Middle of the device will move up or down, providing the desired outer rotation. After the outer rotation is set, fix it with pins by the holes (Picture 7.)

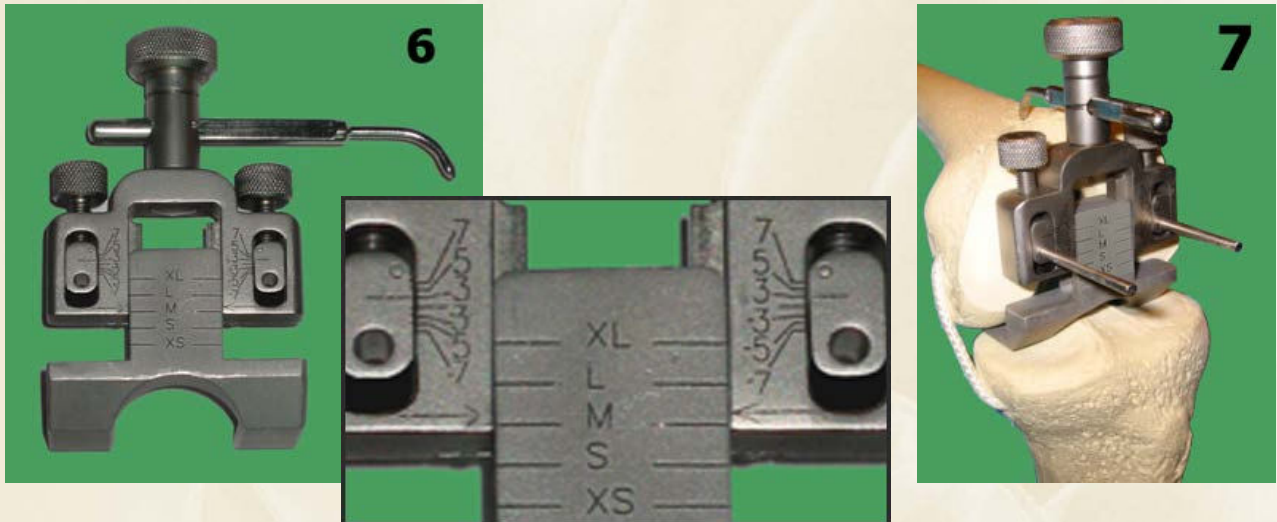

Place the cutting block (classic type: 735-0018-0003/-0007 Minimal invasive type: 735-0018-0013/-0017) of the suitable size, onto the pins, in the rotation position that was set in the previous step (Mostly 3°). (Picture 8.).

Make sure that the first resection does not reach the femur's anterior cortical. Then perform the 4 resections as indicated on the block.



**Important:**

For best results, always use a new 1mm-thick saw blade for each operation.

During resection, the more force applied to the saw, the more likely it is to get diverted by the sclerotic bones. The use of saw guide blocks reduces the extent of bending of the saw blade.

In case metal debris is noticed during sawing, this could be an indication of a wrong technique applied. In such cases the plane of the saw blade should be corrected.

Finally, the fixation pins and the cutting block are removed. The planes should be checked and if necessary corrections should be made.



## **P/S Femoral component**

After completing the outline resections, centre the universal femoral box cutting guide (735-0018-0009) medially/laterally on the surface of the distal femur, with the anterior flange of the guide laying on the cut surface of the anterior femoral bone (Picture 9.).

Secure the guide with 2 to 4 fixation pins.

Using an oscillating saw, cut the medial and lateral portions of the bone in the notch.

Using the box cutting chisel (735-0021-0006), remove the remaining bone from the femoral notch (Picture 10.).





## 2nd step

### A) Proximal resection of the tibia – The extramedullary technique

The next step is to perform the proximal resection of the tibia. This can be done with the help of an extramedullary aiming device.

Assemble the extramedullary tibial cutting block guide, to the “telescopic handle” (735-0019-0019) - with the tibial cutting block on its tip.

For the larger sized tibia (M, L, XL) the larger size cutting block is used (735-0018-0018), for smaller sized tibiae (XS and S) the smaller cutting block (735-1018-0018) is used (Picture 11.)



**The resection plane should be adjusted** in such a way that is most suitable to the anatomical position of the tibia. If necessary, it can also be adjusted at 7° angle in the ventral direction (the angle adjustment can be increased or decreased).

This adjustment can be aided with the graduated scale found on the extramedullary guide rod of the tibia cutting block (Picture 12.), and the appropriate angle adjustment can be checked with the help of the resection height gauge that is fitted to the tibia cutting block (Picture 13.).



In case it is desired to adjust the slope to a different angle, this can be achieved by sliding the scale - found at the bottom of the extramedullary rod of the cutting guide - up and down (Picture 12.).

**The height of the tibial horizontal resection is controlled by two possible ways of applying the stylus (Picture 14.):**

1. By resting the longer and higher stylus arm on the highest lateral part of the tibia- a **10mm resection** is ensured.
2. While by turning the stylus, its smaller and lower arm can be rested on the tibial deepest medial point. The latter position results in the least resection and bone removal volume, ensuring a **2mm resection** as compared to the tibial medial plane.



If the damage of the tibia is moderate, then a 2 mm resection from the deepest medial point is performed.

If the damage is significant, then make a 10 mm resection laterally, in case you want to implant a cruciate retaining component.

It should be taken into consideration, that if the height of the lateral resection exceeds 10mm, then the implantation of a posterior stabilized femoral and tibial component is necessary.

## **B) Proximal resection of the tibia – The intramedullary technique**

Prepare the knee by placing it at its maximal flexion position, and determine the tibial plateau midpoint.

The point of entry to the intramedullary canal is then identified. It should fall posteriorly to the anterior cruciate ligament.

Penetrate the intramedullary canal using a drill.

Following the drilling, the resection block is placed in its position, and the Premier II tibial resection guide is fitted on it.

Insert the T-handled fluted rod into the tibial resection guide, and push through into the intramedullary canal (Picture 15.). This fluted rod will help drive out bone marrow.

Proper positioning of the resection guide on to the tibial external cortex should be well checked.

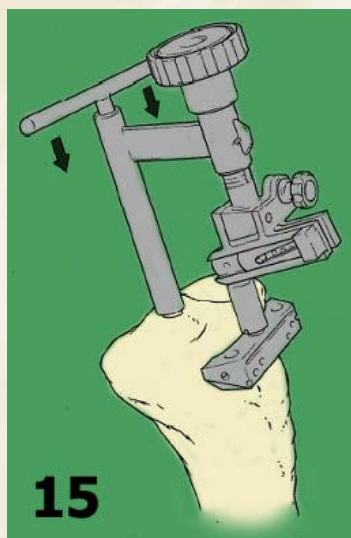

Any adjustment needed to the angle of resection of posterior slope (Picture 16.) can be easily achieved by moving the lever to the desired angle (Picture 17.). Available angle options are: 0°, 3°, 5°, 7°, and 10°

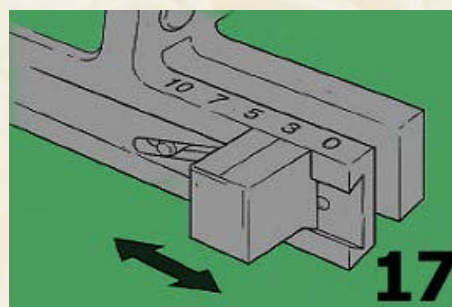
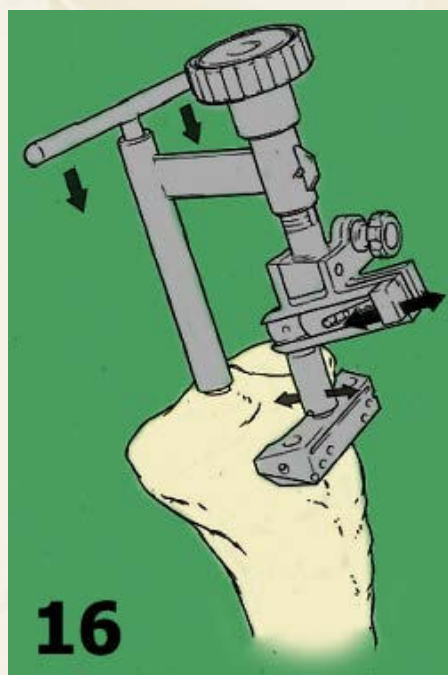

Place the tibial depth gauge into the resection guide from the lateral plateau side, or the side that is less engaged during this operation. Depth gauge is used to indicate the level of resection to be carried out. (This is usually 9mm, measured from the normal tibial plateau). (Picture 18.).

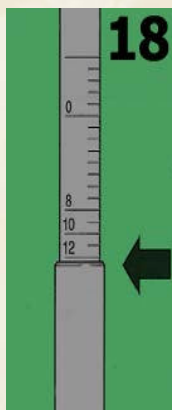

**For setting level** turn the knob at the tip of the device (Picture 19.).

**To lower** the resection guide: turn the knob counter clockwise.

**To raise** the resection guide: turn clockwise.

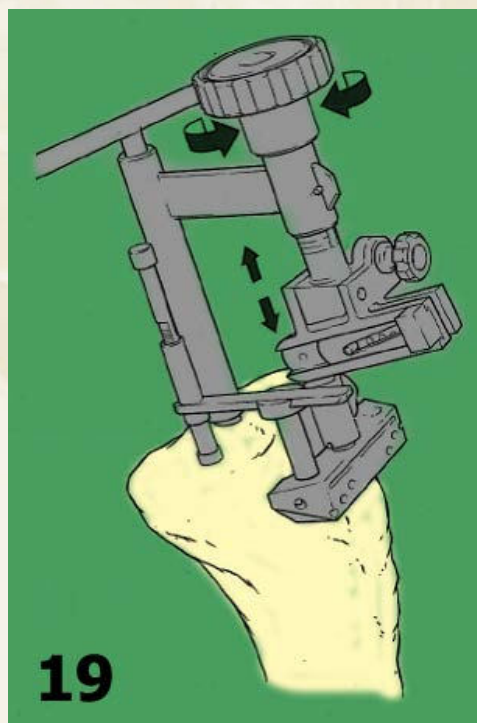



For medial and lateral alignment, connect the telescoping alignment rod to the tibial resection guide (Picture 20.).

The alignment rod divides the talus into 2 parts at the joint line (Picture 21.).

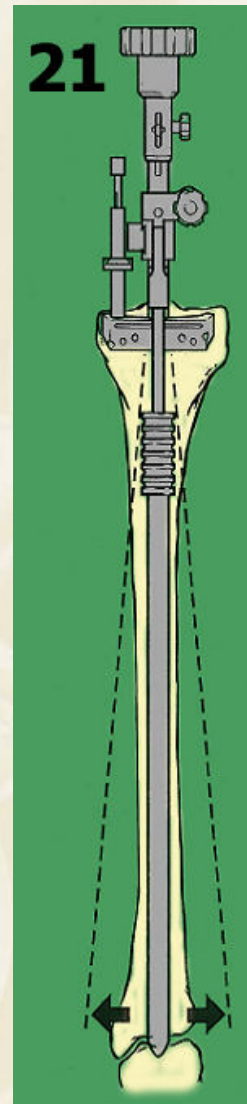
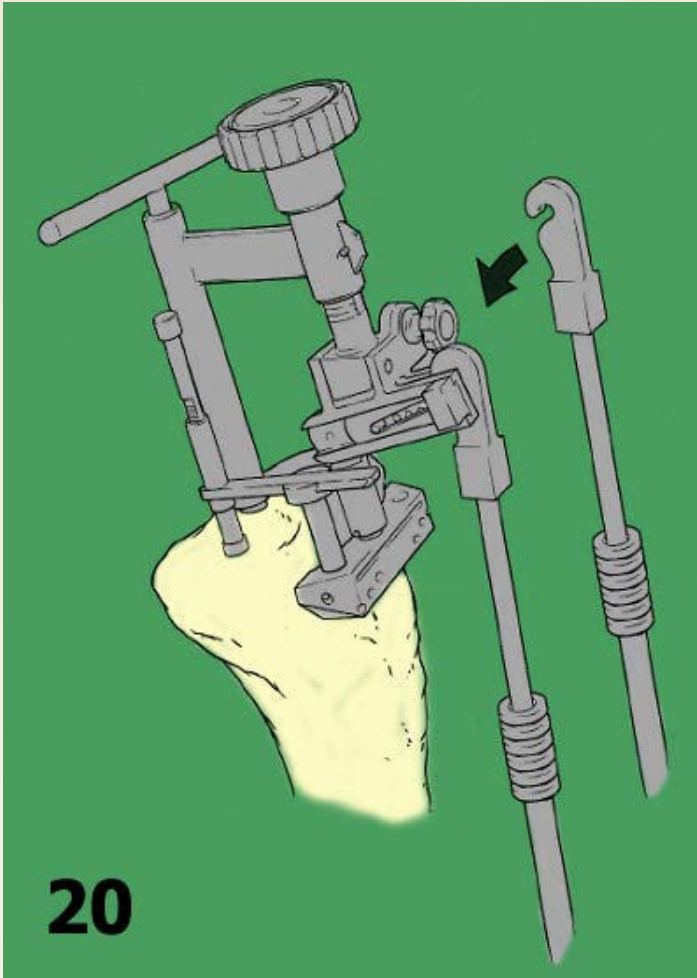

**For adjusting the medial-lateral alignment**, loosen out the knob, which is present over the posterior slope lever a little bit, and then re-adjust the rod position.

**When the alignment marks present on both the knob and the guide meet together, the guide will be at 0° of medial – lateral rotation.**

Use drills to fix the cutting block on to the tibia, or alternatively use fixation pins.

Remove the resection guide and rod, but not the resection block. (Picture 22.).

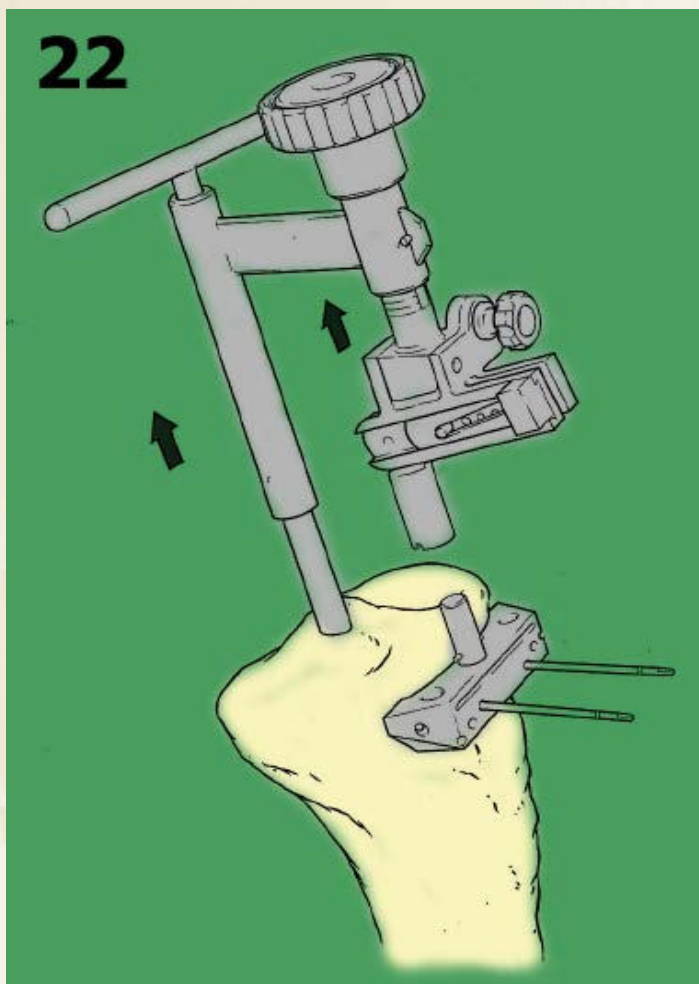

Resect the plateau with an appropriate 1 mm saw blade. Extra rows of holes are available for an additional 2mm resection.

### 3rd step

#### Fixing up the trial femoral component

Place the appropriate size of the chosen trial femur on the already prepared distal femoral part.

As the tolerance of the sawing slits is very low, you should place the components with the help of the premier II inserter/extractor device (735-0002-0001). (Picture 23).



The medial-lateral placing of the femur implant can be then freely defined. Apply strokes on the component using a rider until it is half way fitted (picture 24).



Remove the placing device by loosening the ridged screw, and impact on the trial component with the definite femur impactor (735-0001-0003) till it is completely fitted in place (Picture 25).



When the correct position is reached, drill through the lateral and medial condyle holes in the femur using the condyle drill bit (735-0007-0004). (Picture 26).





## **4th step**

### **Trial reposition**

#### **Checking of the flexion and extension joint gap**

Place a suitable trial tibial plate (735-0009-0100, -104) on the dissected tibial plateau using the thinnest trial tibial insert and move the limb carefully throughout the entire movement-range of the limb. The flexed and extended joint gap checking has to get through the following basic steps:

1. The soft pressure at extension determines the extent of the femoral distal construction.
2. The extent of the posterior femoral condylar construction is determined by the soft pressure at flexion. The extent of the tibial construction is determined by the pressure at the extension as well as at flexion.

A proper leg balance has to be achieved by the construction process. If the surgeon wishes to carry out further fine adjustments to the balance, he has to do that in a careful manner with constant checking on the flexion and extension gap.

#### **1. Bending contraction default:**

In this case the full extension shows that the joint's column is narrower when extended as compared to that at flexion, the extension joint gap has to be sawed to the right size, so that it adapts to the bending joint gap, i.e. the distal femoral resection and the femoral component at a more proximal positioning.

Repeat here the distal femoral resection and the femur construction steps.

#### **2. Imperfect narrowness at extension and flexion of joint gap.**

Detachment due to inadequate soft pressure, or generally inadequate bone cutting. Enlargement of the extension and flexion gap could be achieved by further resection of the proximal tibia. This means that the flexion gap is smaller than the extension gap. This is shown by the enlargement of the trial tibial plateau opening, with increased bending.

The flexion gap can be increased with posterior inclination or by decreasing the femoral component size, i.e. with the ventral positioning of the femoral condylars.

#### **FUTURE Knee Rotating Knee**

By implanting **FUTURE Knee Rotating** tibial tray and insert, special tibial tray and insert trials are available.

## 5th Step

### The tibial plateau final preparation.

Chose a tibial plateau size, which properly fits on the rims of the dissected proximal tibia (picture 27)



Fix the handle of trial tibial tray with the help of the ridge-headed screw. Insert the straightening rod by vertical bending into the clamp. Place the gauge and straighten out the round shaped rod clamp with the other finger (picture 28).



Alternatively:

Place the trial component, the femur and the tibia, and move the leg several times through out the entire possible movement range. Let the tibial plateau rotate into the right position. Place a reference point with the help of HF instrument or colour mark (e.g. methyl blue) on the trial plateau's front edge.

Drill the front slope holes with a 3,2 mm drill bit, and fix the plateau with two fixation pins (picture 29).



Place the tibial drill guide (735-0008-0009) on to the trial tibial tray, and use the 7,8mm drill bit to prepare the initial hole for the tibial stem (picture 30).



Afterwards take the introducing guide (735-0008-0010), the handle (735-0021-0005) and the tibial punch (735-0021-0001) for the tibial stem (picture 31).



Place these together on to the appropriate holes on the plateau (picture 32).



With mild strokes tap in the chisel until it meets the clamp in the guiding hole. Then remove the chisel, the fixating screw and the plateau.



## 6th Step Preparation of the patella

Remove all outer osteophyte, and try to approximately restore the anatomical form. The resection area and the position that arises from that are essential for the patella's proper functionality. The dorsal joint surface is demonstrable by tipping it over.

Measure the bone strength with help of patella calliper. A bone layer that corresponds to the used patella implant has to be removed.

Fix the patella with the help of the patella resection clamp or pliers and carry out a straight resection.

This has to be exactly started under the deep abraded edge of the subcondrial bone, and to be continued in a straight line at the laterally abraded edge till the uppermost point (picture 33).



This way, a plain coating area is created later for the implant. To this surface a patella drill guide is centrally placed with handle, and a fixating screw is introduced in. (picture 34).

With the help of the patella drill (strokes) the central fixing hole is drilled (picture 35).



Out of the available implant sizes we choose the one, which offers the most covering area without protruding out (picture 36).



Measure once again the total strength of the reconstructed bone and joints. It should not be more than the initial strength, in order to avoid the retro-patellar pressure increase.

Patella trial position:

Check the patella's functioning along with the other prosthesis components. It should be able to freely glide within the trochlea, without slipping to the sides.

In case there is a tendency to slip to one side, a gradual retinaculum cleavage has to be performed to restore the gliding path.

For the cementing of the original components use the patella clamp, so that it aids the solidification of the cement and keeps it fixed on. The extra cement should be eliminated while solidifying.

## 7th Step

### The placement of the original implant

#### Preparations:

Use a piece of the earlier cut out bone as a seal for the intramedullary canal. This can help avoiding post operational bleeding at the site of operation.

The cut bone surfaces are inspected carefully once more. These can be finally thoroughly cleaned using a jet washing system and can be then dried out. The original implants (the appropriately chosen sizes) should be handed over sterile by the trained medical staff.

#### Tibial component:

The monoblock tibial plateau size is selected according to the trial implant size. The insertion of the tibial tray is performed with the tibial tray inserter (735-0001-0002) (picture 37).



The cement is spread over the lower part of the tibial component and the dissected tibial bone surface, after placing the implant in the proper position (picture 38, 39).



Remove the inserting instrument and then tightly impact the modular component with the help of the tibial impactor.

The cement surplus is removed with the help of a scraper.

The components can be implanted simultaneously with the help of the cement mixture, or one after the other.

The tibial components are usually implanted first, except in the case of P/S implants, where the femoral component should be implanted first.

During the cement solidification phase, the tibial original implant or the tibial trial insert may be placed once more as preferred on the original tibial tray implant.

### **The tibial insert gliding surface condition**

The original tibial insert gliding surface is fitted on to the metal plate flatly from the frontal side, minding the roundly pitted offset on the surface of the tibial metal plate while fitting (picture 40).





The tibial insert is finely tapped with the gradual round tibial insert impactor (735-0001-0004) to firmly slide into position in the depth of the metal plateau.

This kind of slide-in fixation of the tibial inserts from the frontal side helps to avoid any postoperative impingement.

A 3,5 mm hex screwdriver (735-0005-0001) is used to tighten the fixation screw through the tibial insert into the metal plateau (Picture 41).



By implanting modular type tibia plateau (BIOTECH FUTURE KNEE Modular Total Knee) the procedure of primary implantation is the same as described above.

**Femoral component:**

The low viscosity cement needs to be also spread on the entire internal surface of the femoral component and on all cut out surfaces of the femur.

The femoral implant is then held in the inlay instrument and fitted on the cut out femur. (Picture 42).



The femoral component has to be impacted with the premier II. inserter/extractor device (735-0002-0001). When the right position is achieved, remove the instrument with loosening the ridged screw (picture 43, 44).

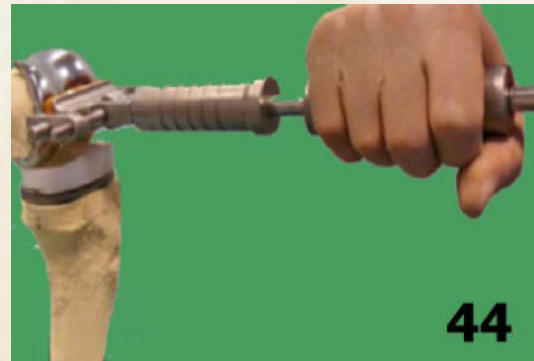

With the femoral impactor (735-0001-0003) the corrections can be performed.

After the positioning of the implant the extra cement is carefully removed, especially at the area of the posterior condyles.

The cement solidification process occurs, while the patient's leg is stretched out and a hyperextension is achieved.

**FUTURE Knee femoral and tibial resection instruments  
Minimal Invasive  
735-1017-0001**

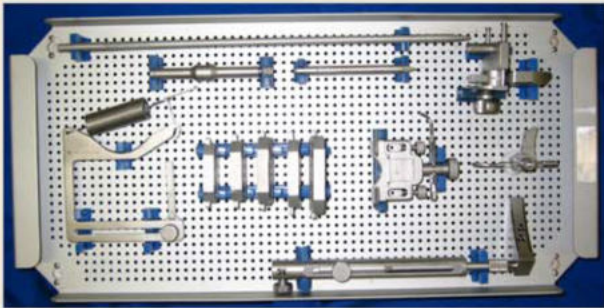

**FUTURE Knee Tibial/Patellar instrument set  
735-0017-0002**

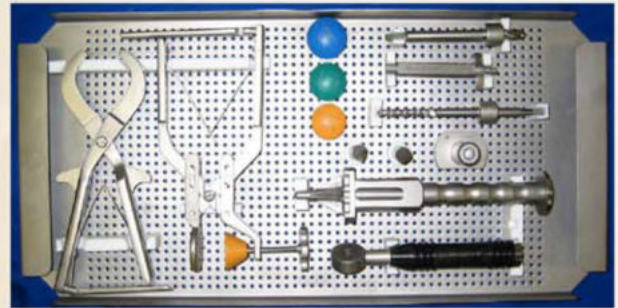

**FUTURE Knee Femoral/Tibial Impactor instrument set  
735-0017-0003**

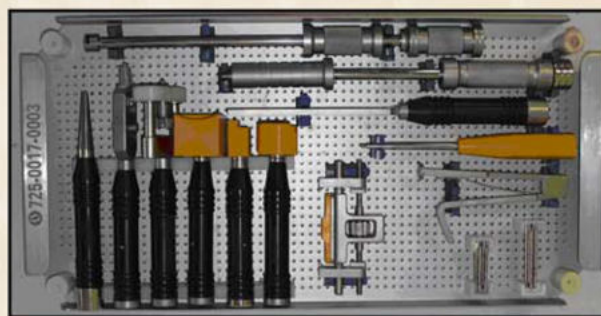

**FUTURE Knee Femoral/Tibial trial instrument set  
735-0017-0004**

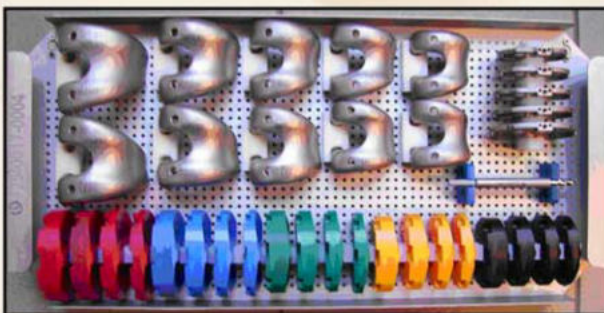

**FUTURE Knee P/S Femoral/Tibial trial instrument set  
735-0017-0005**

